

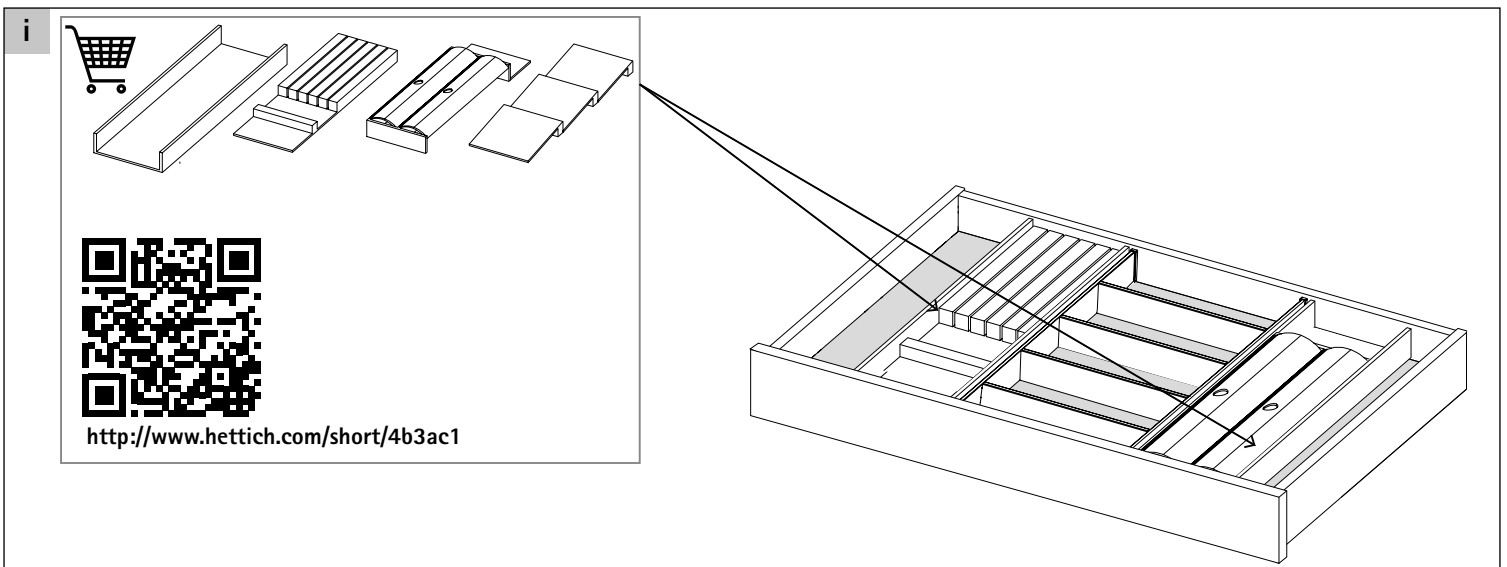

# OrgaTray 630

Technik für Möbel

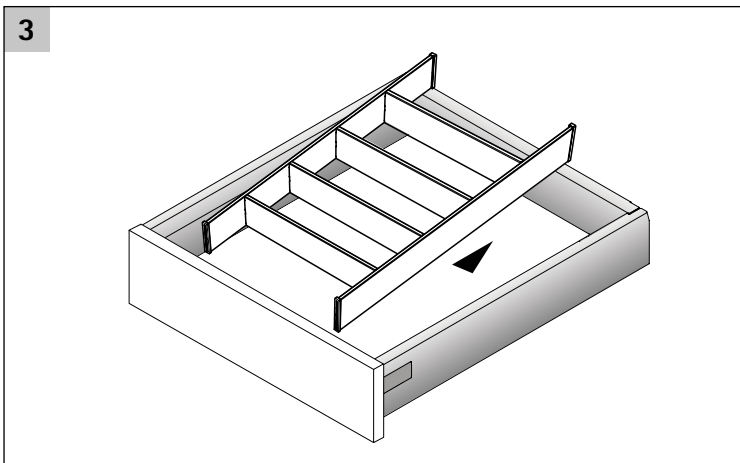
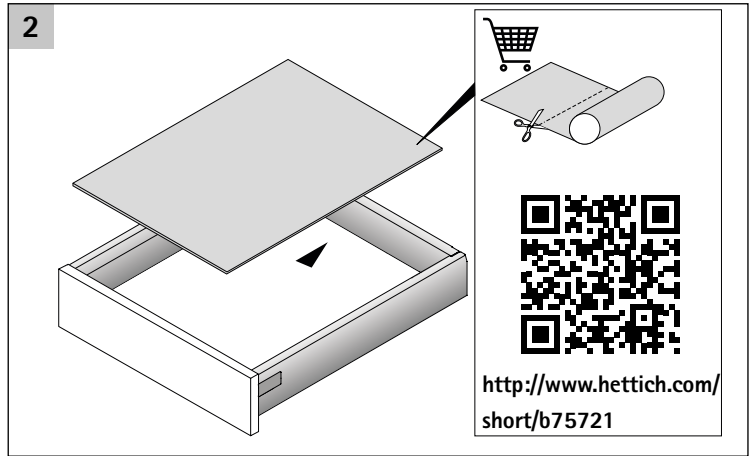
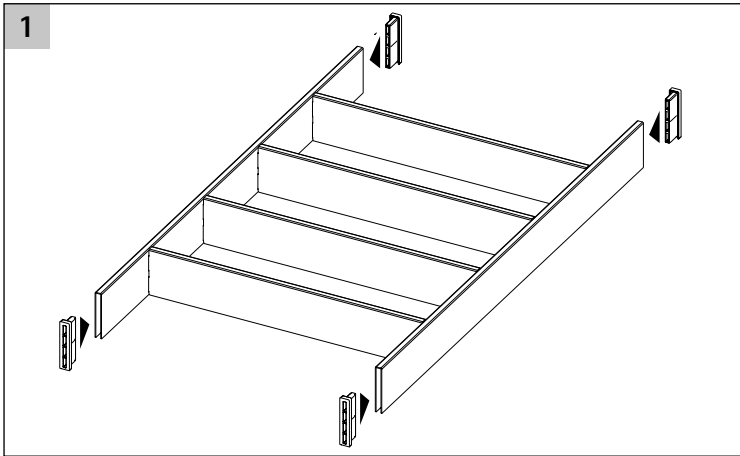

i	NL	T		NL	T		NL	T		NL	T	
	450	423		470	461		500	473		520	511	
	B		271	271		271		271		271		
	KB		≥ 350	≥ 400		≥ 350		≥ 400		≥ 350		
	AvanTech YOU		≥ 400	≥ 400		≥ 400		≥ 400		≥ 400		
	ArciTech											
	InnoTech Atira			≥ 400								

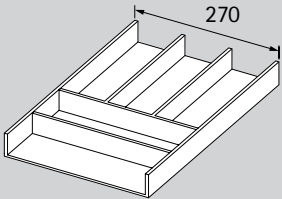
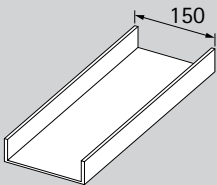
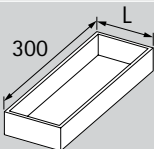
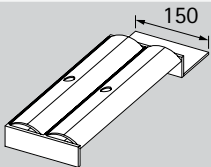
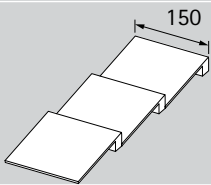
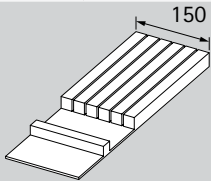
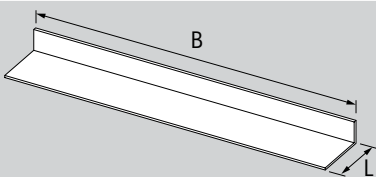
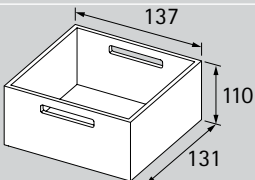
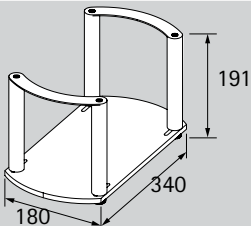

	AvanTech YOU / ArciTech		InnoTech / InnoTech Atira
	NL 450	NL 500	NL 470
<b>A</b> 	9 278 291	9 278 292	9 287 303
<b>B</b> 	9 278 293	9 278 294	9 278 304
<b>C</b> 	<b>C1</b> L = 105 mm 9 278 302	L = 118 mm 9 278 301	L = 115 mm 9 278 308
<b>D</b> 	9 278 297	9 278 298	9 278 306
<b>E</b> 	9 278 299	9 278 300	9 278 307
<b>F</b> 	9 278 295	9 278 296	9 278 305
<b>G</b> 	L = 100 mm B = 600 mm: 9 278 313 B = 1200 mm: 9 279 203		L = 89 mm B = 600 mm: 9 278 314 B = 1200 mm: 9 279 204
<b>H</b> 	9 278 309		
<b>I</b> 	9 278 310		
<b>J</b> 	9 278 312		

i

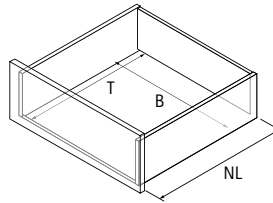
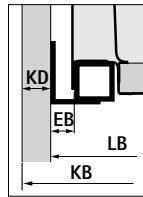
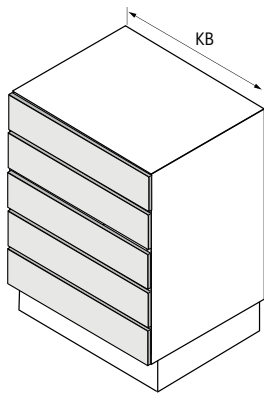

	B	T
AvanTech YOU	LB - 42	NL - 27
ArciTech	LB - 2 x EB - 62	NL - 27
InnoTech / InnoTech Atira	LB - 2 x EB - 59	NL - 8

KB ≥ 300 AvanTech YOU  
KB ≥ 350 ArciTech, InnoTech Atira

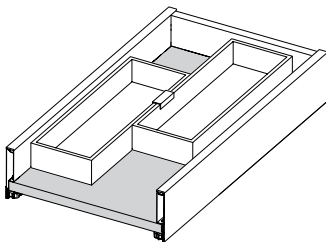

2 x **C1** + 1 x **J**

KD ≤ 19 mm

KB ≥ 350 AvanTech YOU  
KB ≥ 400 ArciTech, InnoTech Atira

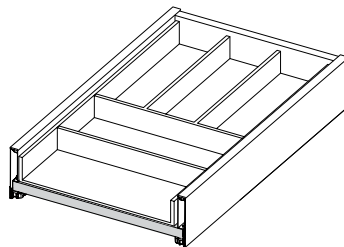

1 x **A**

KD ≤ 19 mm

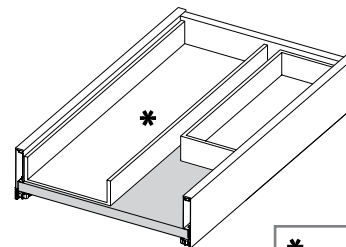

1 x **B** + 1 x **C**

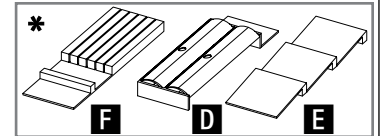

KB ≥ 400 AvanTech YOU  
KB ≥ 450 ArciTech, InnoTech Atira

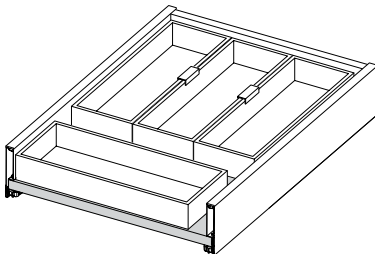

3 x **C1** + 1 x **C** + 2 x **J**

KD ≤ 19 mm

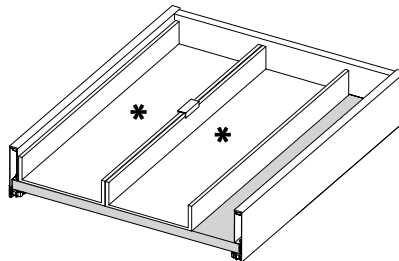

2 x **B** + 1 x **J**

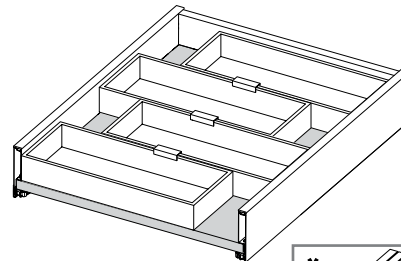

4 x **C** + 3 x **J**

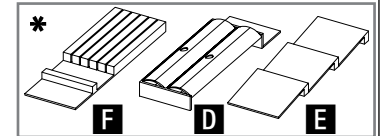

KB ≥ 450 AvanTech YOU  
KB ≥ 500 ArciTech, InnoTech Atira

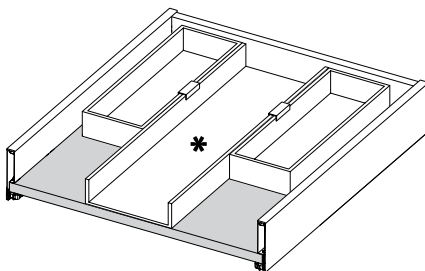

1 x **B** + 2 x **C1** + 2 x **J**

KD ≤ 19 mm

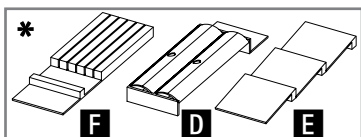

KB ≥ 500 AvanTech YOU  
KB ≥ 550 ArciTech, InnoTech Atira

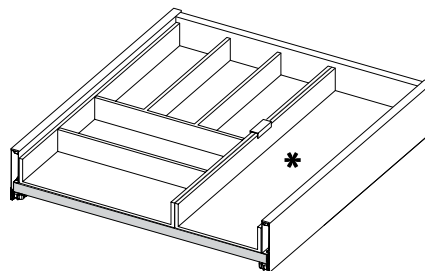

1 x **A** + 1 x **B** + 1 x **J**

KD ≤ 19 mm

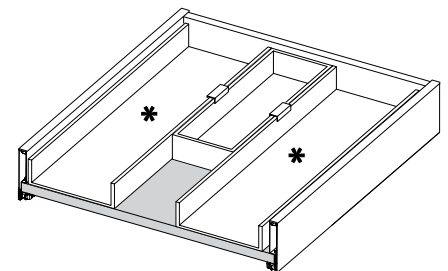

2 x **B** + 1 x **C** + 2 x **J**

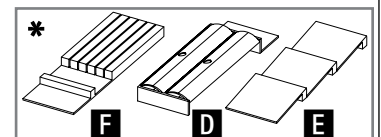

KB ≥ 550 AvanTech YOU  
KB ≥ 600 ArciTech, InnoTech Atira

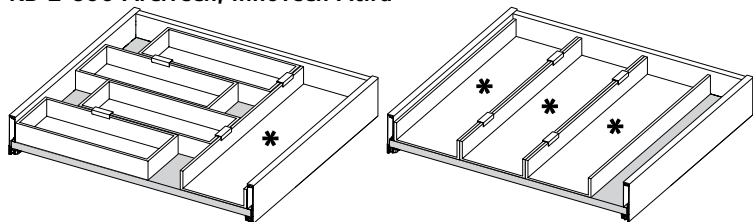

1 x **B** + 4 x **C** + 4 x **J**

3 x **B** + 4 x **J**

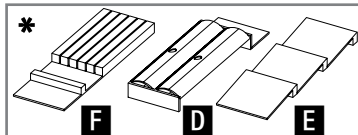

KD ≤ 19 mm

KB ≥ 600 AvanTech YOU  
KB ≥ 650 ArciTech, InnoTech Atira

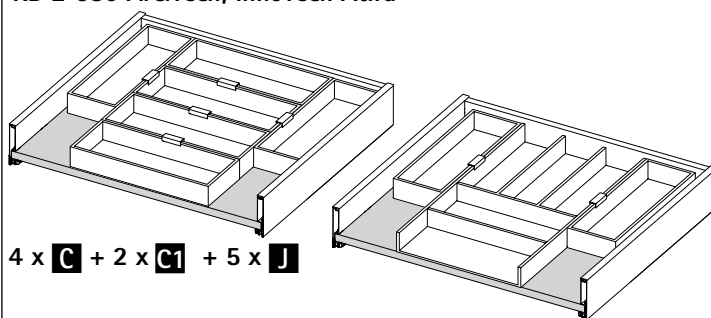

4 x **C** + 2 x **C1** + 5 x **J**

1 x **A** + 2 x **C** + 2 x **J**

KD ≤ 19 mm

KB ≥ 650 AvanTech YOU  
KB ≥ 700 ArciTech, InnoTech Atira

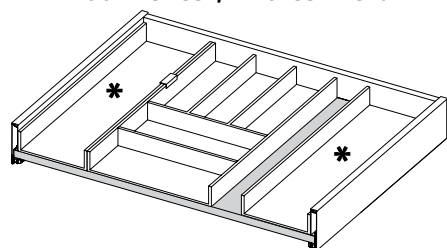

1 x **A** + 2 x **B** + 1 x **J**

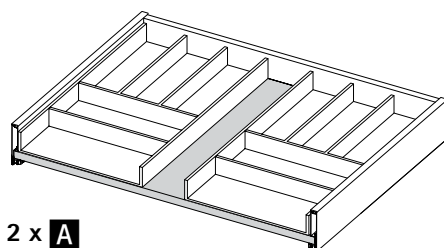

2 x **A**

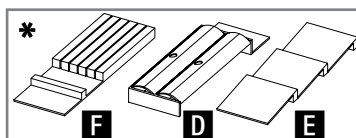

KD ≤ 19 mm

KB ≥ 750 AvanTech YOU  
KB ≥ 800 ArciTech, InnoTech Atira

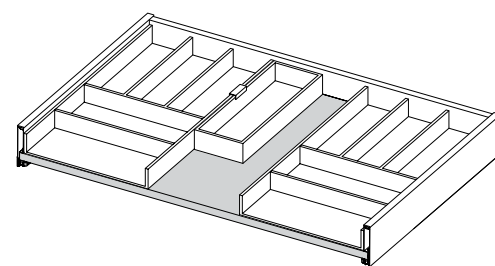

2 x **A** + 1 x **C** + 1 x **J**

KD ≤ 19 mm

KB ≥ 800 AvanTech YOU  
KB ≥ 850 ArciTech, InnoTech Atira

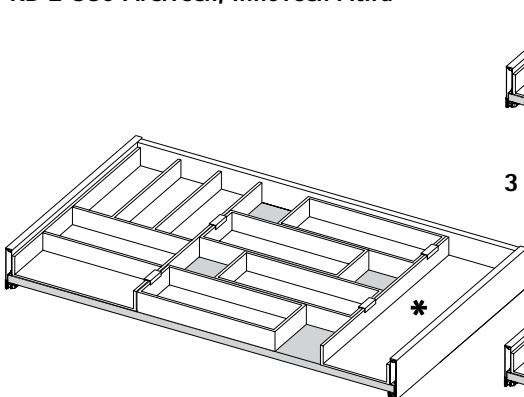

1 x **A** + 4 x **C** + 1 x **B** + 4 x **J**

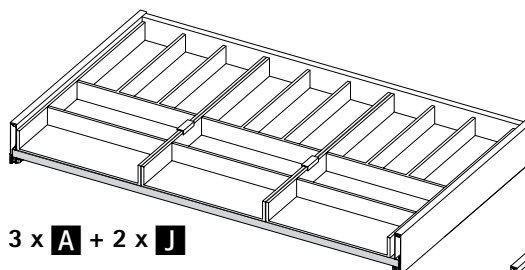

3 x **A** + 2 x **J**

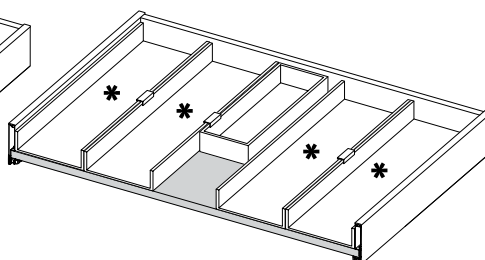

4 x **B** + 1 x **C** + 3 x **J**

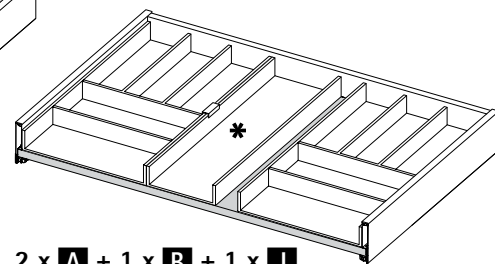

2 x **A** + 1 x **B** + 1 x **J**

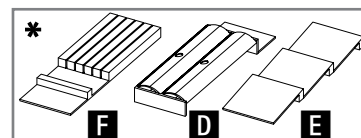

KD ≤ 19 mm

KB ≥ 900 AvanTech YOU  
KB ≥ 950 ArciTech, InnoTech Atira

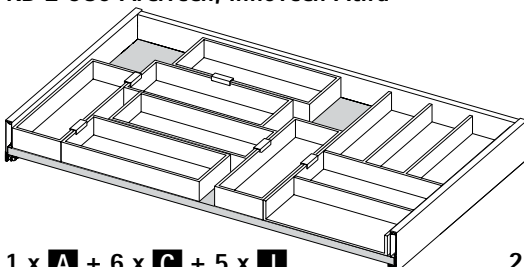

1 x **A** + 6 x **C** + 5 x **J**

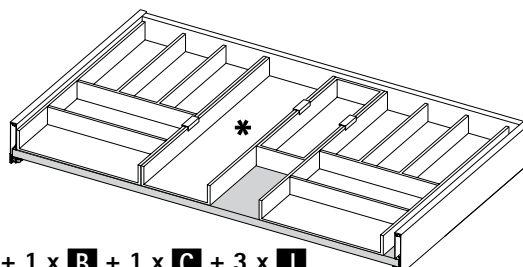

2 x **A** + 1 x **B** + 1 x **C** + 3 x **J**

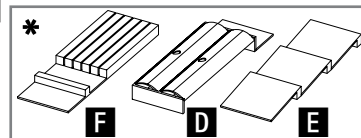

KD ≤ 19 mm

KB ≥ 950 AvanTech YOU  
KB ≥ 1000 ArciTech, InnoTech Atira

KD ≤ 19 mm

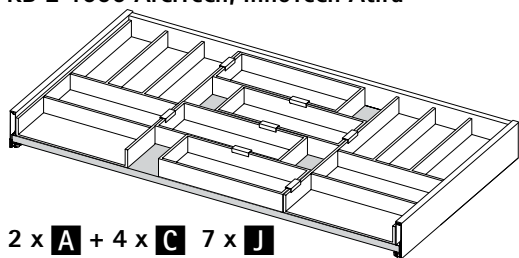

2 x **A** + 4 x **C** 7 x **J**

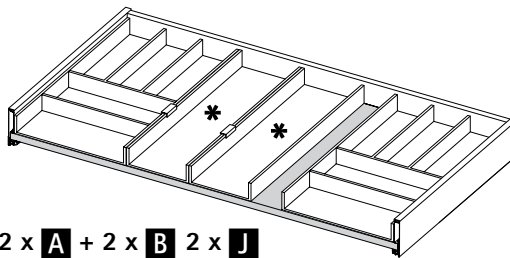

2 x **A** + 2 x **B** 2 x **J**

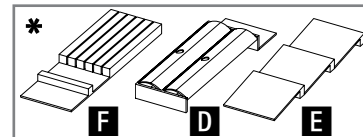

KB ≥ 1000 AvanTech YOU  
KB ≥ 1050 ArciTech, InnoTech Atira

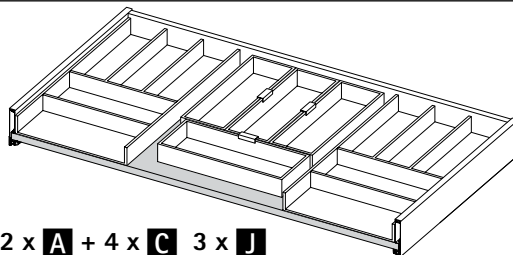

KD ≤ 19 mm

2 x **A** + 4 x **C** 3 x **J**

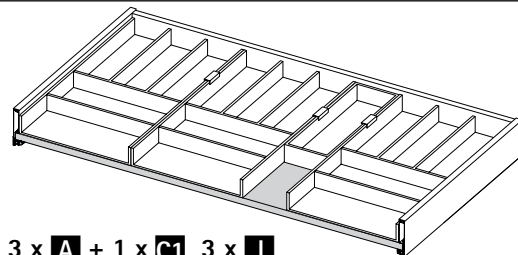

3 x **A** + 1 x **C1** 3 x **J**

KB ≥ 1150 AvanTech YOU  
KB ≥ 1200 ArciTech, InnoTech Atira

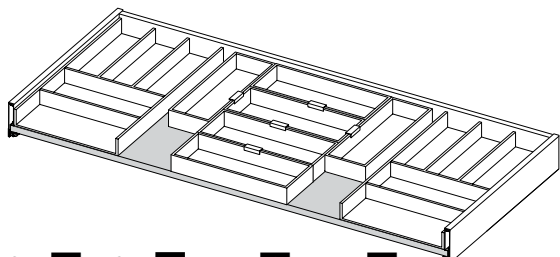

2 x **A** + 2 x **C1** + 4 x **C** + 5 x **J**

KD ≤ 19 mm

KB ≥ 1200 AvanTech YOU

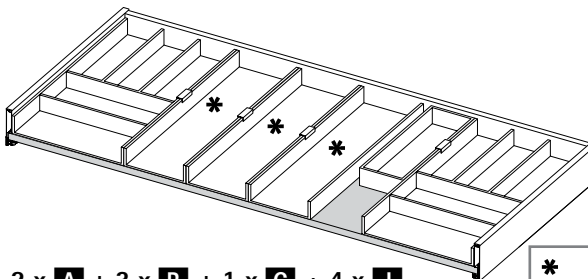

2 x **A** + 3 x **B** + 1 x **C** + 4 x **J**

KD ≤ 19 mm

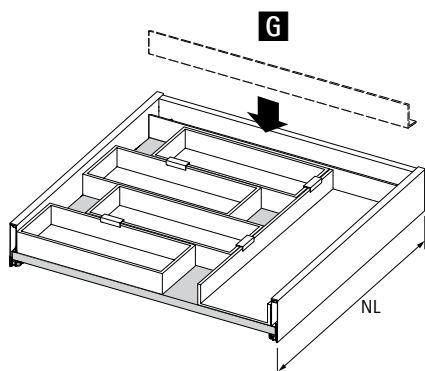
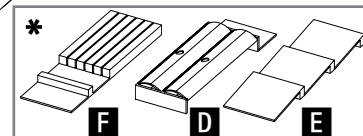

AvanTech YOU, ArciTech	NL			L = 100 mm B = 600 mm: 9 278 313 B = 1200 mm: 9 279 203
	450	<b>A - F</b> , NL 450		
	500	<b>A - F</b> , NL 500		
	550	<b>A - F</b> , NL 450		+ 1x <b>G</b> L = 100 mm
	600	<b>A - F</b> , NL 500		+ 1x <b>G</b> L = 100 mm
650	<b>A - F</b> , NL 450		+ 2x <b>G</b> L = 100 mm	
InnoTech Atira	NL			L = 89 mm B = 600 mm: 9 278 314 B = 1200 mm: 9 279 204 L = 100 mm B = 600 mm: 9 278 313 B = 1200 mm: 9 279 203
	470	<b>A - F</b> , NL 470		
	520	<b>A - F</b> , NL 450		+ 1x <b>G</b> L = 89 mm
	570	<b>A - F</b> , NL 470		+ 1x <b>G</b> L = 100 mm
	620	<b>A - F</b> , NL 450		+ 1x <b>G</b> L = 89 mm + 1x <b>G</b> L = 100mm

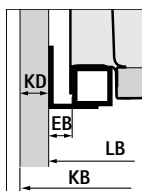
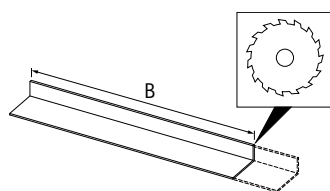

AvanTech YOU	B = LB - 42
ArciTech	B = LB - 2 x EB - 62
InnoTech Atira	B = LB - 2 x EB - 59